

Toronto PLUG 2014

A Complete Metering Portfolio to
boost *Growth*

October 17, 2014

Rene Jonker

Director, Offer Management – PMQ Metering



Growth Opportunities with PowerLogic

Entry Range



EM3500

Basic Range



6200



PM5100



PM5300



PM5500



Enercept

Intermediate Range



PM810/820/850



ION 7330/50

Advanced Range



ION7550/7650

Current Transformer



Current Transformers

Multi-Circuit Metering



EM4800



BCPM



BCPME



HDM

Utility Revenue



ION8650

More growth Opportunities with EasyLogic

Entry Range



DM6000 Volt, Amp,
Frequency Meters



PM1000 Multi-
Function Power Meter

Our Customer's Voice:

Improve Reliability

“Help my enterprise run reliably”

Network Management

- 700 M€ PAM + 5%
- +8% growth
- Large industrials, critical buildings, utilities

Network management

“Help me make my equipment run optimally”

Asset Management

- 400 M€ Market* + 15%
- +15% growth
- Large industrials



“Help me save money on my energy costs”

Cost Management

- 420 M€ PAM + 20%
- +20% growth
- Non-critical buildings

Improve Asset Performance

Improve Financial Performance

Application Based Positioning

Energy Management Framework

Reduce energy cost

Energy Cost Management

- Energy Savings
- Energy Optimisation
- Carbon & Procurement optimization

Increase comfort or productivity

ED Network Management

- Protection
- Monitoring
- Control

Optimize equipment utilization

Asset Management

- Use Optimisation
- Condition Based Monitoring
- Predictive Maintenance

Simple cost management

Simple network management

- Market price
- Transactional sales

Expert network management

Expert asset management

- Performance & customization
- Premium price
- Consultative sales

Expert cost management

Expert network management

Simple asset management

- Premium price
- Consultative sales

Intermediate

Basic

Entry

Entry Medium

Advanced Utility

Advanced

Cost management
Network management

- Cost-effective
- Transactional sales
- Consultative sales

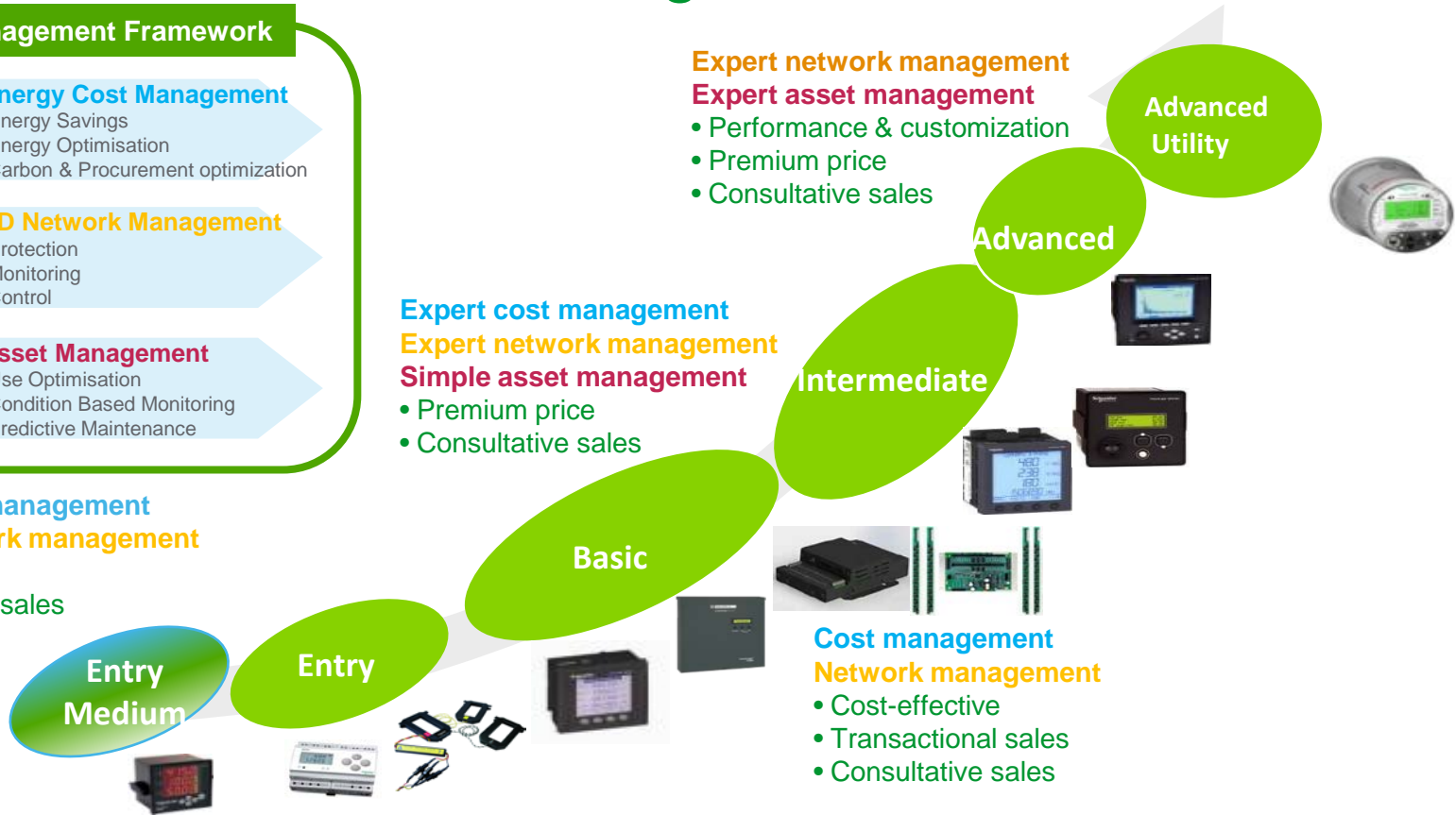

Growth Opportunities

Application	Comments	Growth
Cost Management	Emerging market. Regulations around energy efficiency and environmental monitoring driving the growth	+++
Network Management	Mature market, driven by new construction. Systems approach will drive differentiation in market.	+
Asset Management	New Market. Early to determine size and key differentiators. Will appeal to same buyers as network management. Value sell	++

Segment	Comments	Growth
Critical Buildings	IT driven by data center market growth and high energy cost. Healthcare driven by demographics and need to manage cost. Both require high reliability network management and high accuracy cost management.	+++
Non-Critical Buildings	Cost management focus. Need offer to meet lowest cost to deploy for energy efficiency mandate/regulation.	+++
Industry	Network management for most process critical applications. Cost Management for high energy consumption processes. Growth to come from Asset Management and easier to manage systems	+
Energy	SmartGrid and distributed generation will drive network management (PQ) and cost management (grid connection) applications.	++

Right metering plan for each application

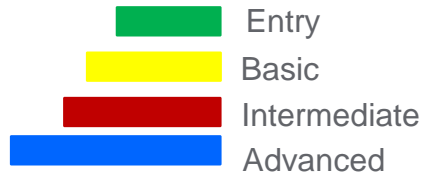

The metering plan involves a different mix of product depending on each segment and application

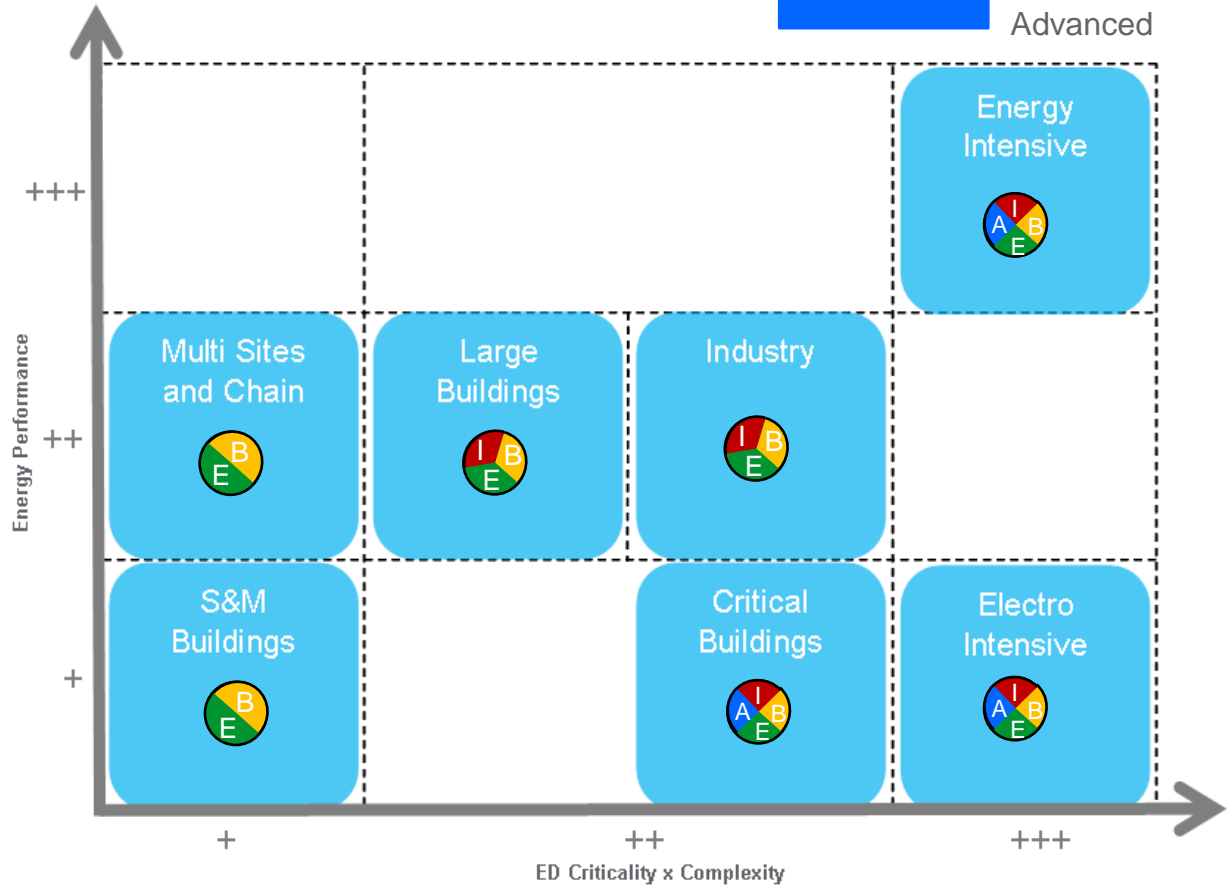
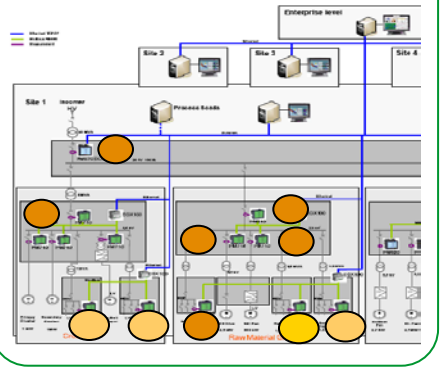

Energy Cost Management

Energy Cost Management

Key Segments

- Commercial buildings (multi-tenant)
- Residential buildings (multi-unit)
- Industrial facilities
- Data centers
- Infrastructure projects (telecommunications)



Key Requirements:

- ✓ **Low Total Cost of Ownership**
- ✓ **Multi-Protocol (Modbus, BMS, Serial/IP)**
- ✓ **Energy Accuracy – 0.5S/0.2S (IEC61052/53)**
- ✓ **Regulatory Compliance (MID, ANSI, RMICAN)**
- ✓ **Multi-tariff & Time of Use**
- ✓ **IEC61557-12 compliance**
- ✓ **Onboard Energy Logging**

EM3500 Family of Energy Meters

Compact meter with ANSI 12.20 0.5% accuracy

Energy Consumption ,Average Power Demand

DIN-rail or wall mounting

All models support a wide range of measurement applications

Models with the output configurations & protocol to meet your needs (Modbus, BACnet)

Uses low-voltage CTs (1V or 1/3V)



EM3500

Pulse output (EM3502)

Pulse outputs of real and reactive energy consumption

Real-time alarm output

All other measurements are available on the built-in display

Modbus output (EM355x)

2-wire RS-485 serial communication with Modbus RTU protocol

1200 baud to 38,400 baud

Also has Pulse Outputs for real energy consumption and real-time alarm output

BACnet output (EM3560)

2-wire RS-485 serial comm with BACnet MS/TP protocol

9600 baud to 115,200 baud

Also has two Pulse Inputs to accommodate sensors measuring other forms of energy



“The value you want, the benchmark metering accuracy you need”



PowerLogic PM5000 series

Cost-effective, accurate, and reliable power meters from the world leader in power metering

Partner benefits



Ease of integration into larger systems and solutions with dual Ethernet and proper protocols, thus saving them time (and money)

Ease of setup thanks to the intuitive menu navigation on the graphical display, including phasor wiring validation, and onboard web pages

Cost effectiveness since a single product (or product family) that can meet the majority of system requirements

And your customers benefit

Ease of use with intuitive menu-driven navigation and support for 8 different languages

Precision metering/billing thanks to energy metering compliance to IEC 61052/53 ranging from 0.5S to 0.2S

Billing flexibility with compliance to MID and support for up to 8 different tariffs to suite your customers' particular needs

Consistent, superior performance with compliance to international metering standard IEC 61557



PM5000 – Energy Cost Management – PANEL MOUNT

Available
Now

PM5100

- Basic metering with class 0.5S accuracy + pulse output &/or serial comm

PM5300

- Basic metering with class 0.5S accuracy + 2DI/2DO + data logging + multi tariff + Ethernet or serial comms + 2 relay(form A)

PM5500

- Basic metering with class 0.2S accuracy + 4DI/2DO + data logging + multi tariff + Ethernet and serial comms + 4th CT input for neutral & ground measurement + Internal web server



Network Management

Network Management

Key Segments

- Industrial facilities
- Data centers
- Infrastructure projects (telecommunications)



Key Requirements:

- ✓ **Fully Integrated System Solution**
- ✓ **Multi-Protocol & Multi-Port** (Modbus, DNP, IEC61850, DLMS, BMS)
- ✓ **Programmable Logic, Alarming & Control**
- ✓ **Multi-Channel Load Profiling**
- ✓ **Power Quality Monitoring** (Harmonics, Sag/Swell, Unbalances, Flicker, Transients, SOE)
- ✓ **Compliance to Standards** (IEC61000-4-30, EN50160, IEC62586, IEEE 519)
- ✓ **Power Quality Compliance Reporting** (PME 7.2)
- ✓ **Transient Detection & Waveform Capture**

Network Management Metering

Basic Range



PM5100



PM5300



PM5500



Intermediate Range



PM850/870



ION7330/50

Advanced Range



ION7550/7650



CM4000T

Introducing The PM8000

PowerLogic™ PM8000 Power Meter

“Simplifying power quality, maximizing versatility”

Measure, understand, and act upon insightful data gathered from your power system



PM8000 Power Meter

Reveal and understand complex power quality conditions

- > EN 50160 reporting and evaluation with internal web pages
- > IEC 61000-4-30 Class S compliance
- > Waveform capture, sag-swell and disturbance direction detection

Gather and act on facility-wide energy and consumption data

- > IEC 62053-22/24 Class 0.2S active, Class 1S reactive, WAGES
- > Dual Ethernet, RS485, gateway, Modbus, DNP3 and IEC 61850
- > Seamless integration in PME and PSE

Protect your investment

- > Highly adaptable with ION™ technology
- > Modular IO options and multiple form factors

ION technology

Modular, powerful, flexible . . .

- Leverage the power and flexibility of **ION technology** for extensive customization.
- Uses simple “building block” approach.
- Uniquely addresses advanced monitoring and control applications.
- Adapts to changing needs, avoiding obsolescence.

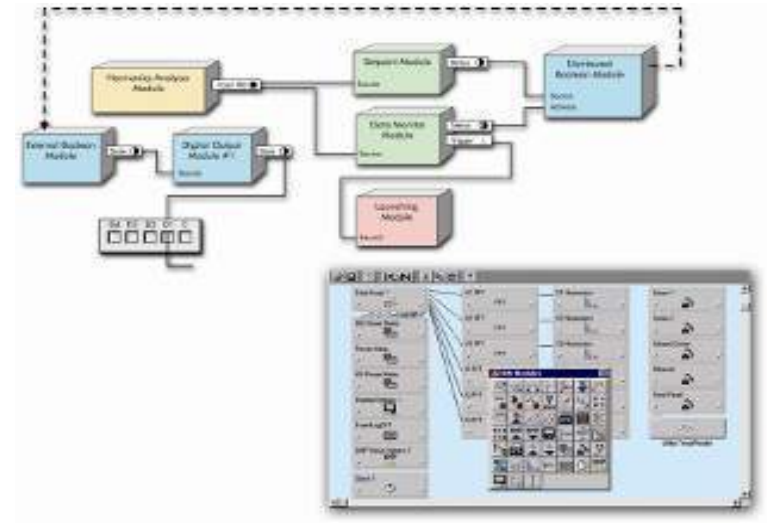

Revenue grade metering with power quality

Energy Accuracy

- > IEC 62053-22 Class 0.2S - Active
- > IEC 62053-24 Class 0.5S - Reactive
- > Revenue security

Power Quality

- > IEC 61000-4-30 Class S
- > IEC 61557-12 / IEC 62586
- > EN50160
- > 4 current inputs
- > Disturbance direction detection



Data server & gateway

Ethernet gateway

Modbus Master

Factory defined and Customizable web pages

E-mail historical data and alarm notification

Multiple protocols

- Modbus, IEC 61850, DNP3
- HTTP, SNMP, FTP, SMTP, NTP, RSTP
- COMTRADE format for waveforms

Dual Ethernet ports allow daisy-chaining to simplify installation and RSTP enables self-healing connections. Ethernet supports multiple concurrent protocols.

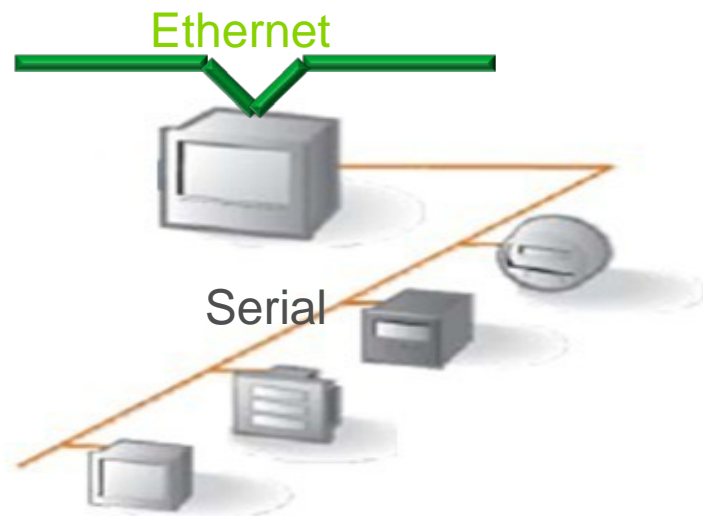

PM8000 - Offer structure

A complete refresh of the Intermediate metering range with new product family:

PM8240

- Class 0.2S meter, Ethernet, ION frameworks, Extensive Load profile, extendable IO, Power quality features **with Integrated display**

PM8243

- Class 0.2S meter, Ethernet, ION frameworks, Extensive Load profile, extendable IO, Power quality features, DIN rail, **with no display**

PM89RD96

- Color remote display

PM8244

- **Transducer meter + remote display** combined in one package

Product Transition

New offer will replace all PM8 and ION73xx references

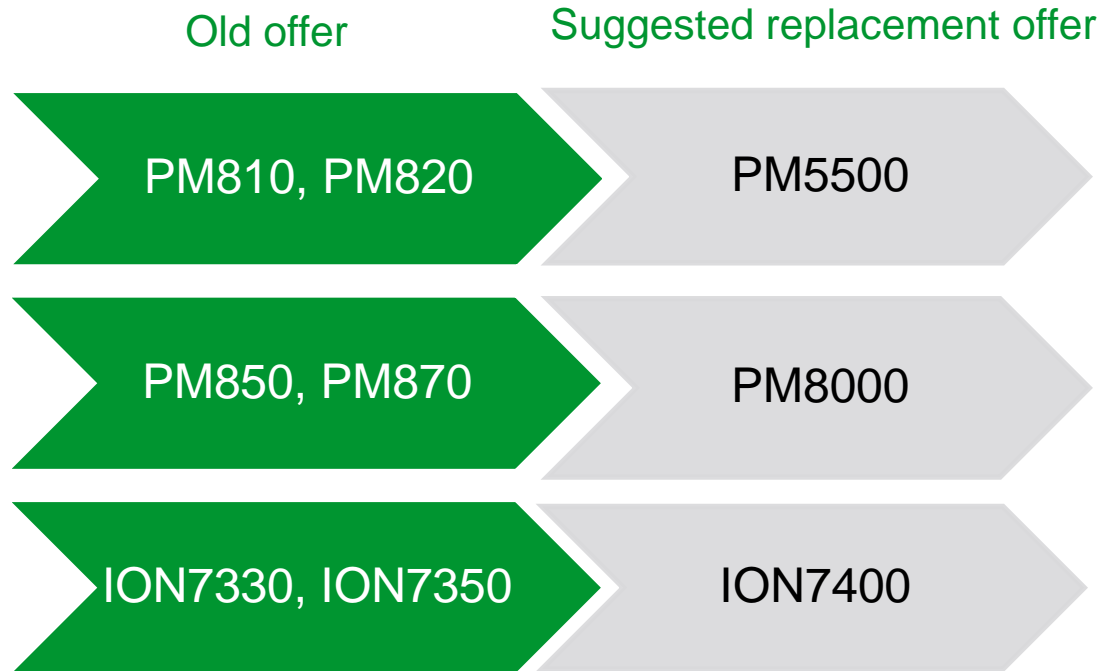

ION 7300 to PM8000 Substitution

Feature	PM8000	ION73xx
Voltage Input	90 – 690 Vac L-L 50, 60, 400 Hz	50 – 347 Vac L-N 50 or 60 Hz
Sample Rate	256 samples/cycle	32 samples/cycle, 64 samples/cycle
Control Power	100 – 415 Vac 100 – 240 Vdc	95 – 240Vac, 20VA 120 – 310 Vdc, 10W
Memory	512 MB (10.0 MB for Frameworks)	0.3 MB
I/O	3 dig In (not wetted), KY	4 dig In (wetted), 4 dig Out
Modularity	Field installable options (x4 DIN / x2 Panel): <ul style="list-style-type: none"> • 6 dig In (w) / 2 relay Out • 4 analog In / 2 Out • Remote display 	Factory options: <ul style="list-style-type: none"> • 4 analog In / 4 Out • Modem, Fiber Ethernet • 20 – 60Vdc control power • Remote display
Frameworks	Yes	Yes
Time Synchronization	IRIG-B (unmodulated – dig In) NTP/ SNTP, GPS (via RS485) Software command	GPS (via RS232 / RS485) Software command
Display	3.5" color TFT	4 line monochrome LCD
Mounting	92 x 92 x 78 mm panel or DIN Option modules: 22 mm (each)	92 x 92 x 162 mm panel, DIN or pan mount
Language Support	English, French, Spanish, Chinese, Italian, German, Russian, Portuguese	English
Communications	10/100BaseTX (x2) - Modbus, ION, DNP3, IEC61850 1x RS485 – Modbus, ION, DNP3	10BaseT (x1) - ModbusTCP / ION over IP 2x RS485 - ModbusRTU, ION, Profibus DP ANSI C12.19 Optical port

PM800 to PM8000 Substitution

Feature	PM8000	PM8xx
Voltage Input	90 – 690 Vac L-L 50, 60, 400 Hz	35 – 600 Vac L-L 50, 60, 400 Hz
Sample Rate	256 samples/cycle	128 samples / cycle
Control Power	100 – 415 Vac 100 – 240 Vdc	115 – 415 Vac, 15VA 125 – 250 Vdc, 10W
Memory	512 MB (10.0 MB for Frameworks)	0.08 MB, 0.8 MB
I/O	3 dig In (not wetted), KY	1 dig In (not wetted), KYZ
Modularity	Field installable options (x4 DIN / x2 Panel): <ul style="list-style-type: none"> • 6 dig In (w) / 2 relay Out • 4 analog In / 2 Out <ul style="list-style-type: none"> • Remote display 	Field installable options (x2): <ul style="list-style-type: none"> • 2 dig In / 2 relay Out • 6 dig In / 2 relay Out • 2 dig In / 2 relay Out / 2 analog In / 2 Out • Ethernet comms, web server, gateway • Remote display
Frameworks	Yes	No
Time Synchronization	IRIG-B (unmodulated – dig In) NTP/ SNTP Software command	DCF77 (via dig In) SNTP Software command
Display	3.5" color TFT	6 line monochrome LCD
Mounting	92 x 92 x 78 mm panel or DIN Option modules: 22 mm (each)	92 x 92 x 70 mm panel or DIN rail Option modules = 20 mm (each)
Language Support	English, French, Spanish, Chinese, Italian, German, Russian, Portuguese	English, French, Spanish, German, Portuguese
Communications	10/100BaseTX (x2) - Modbus, DNP3, IEC61850 1x RS485 – Modbus, DNP3	10/100BaseTX (x1) - ModbusTCP, MBTCP filtering x2 RS485 - Modbus RTU, Modbus ASCII, SYMAX

Panel Mount Meter

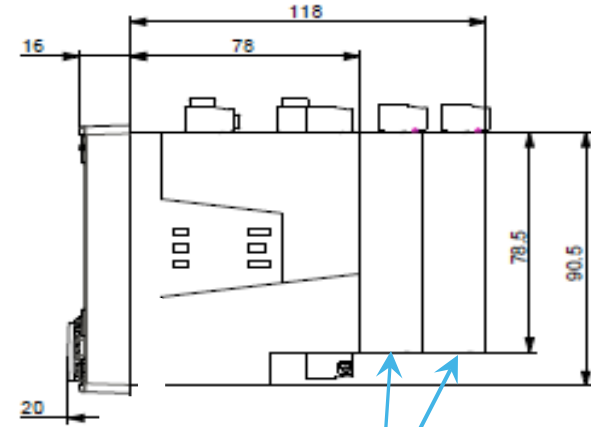
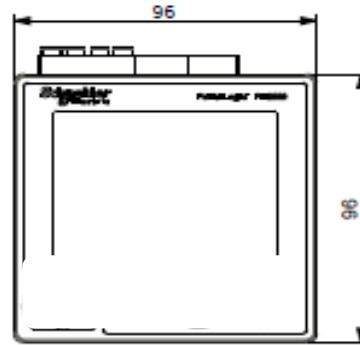

NOTE: Dimensions include two option modules.

DIN Rail Mount Meter

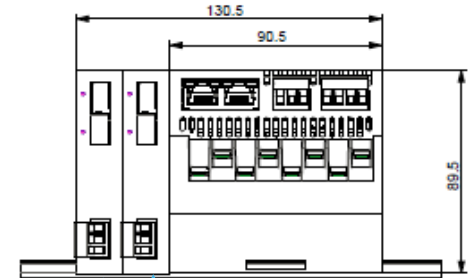
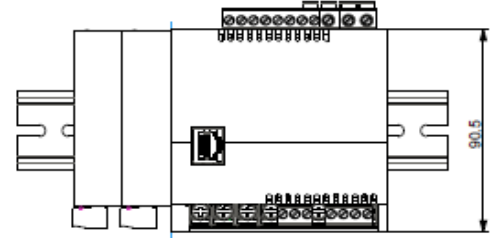

NOTE: Dimensions include two option modules.

Feature summary

Basic

690 V IEC / 600 V UL

Multiple language

Color integrated & remote display models

96 x 96 Form Factor

Modular I/O options:
- 6 Digital in (wetted) / 2 Relay out
- 4 Analog in and 2 Analog out

Cost Management

TOU - 20 year schedule

WAGES metering

Time sync (msec)

Revenue security

Base I/O (3 in / 1 out)

512MB memory
(10MB for Frameworks)

Class 0.2S accuracy

Network Management

EN50160 Analysis

IEC 61000-4-30 Class S

Sag / swell capture

Waveform Capture

Disturbance Direction Detection

Harmonics thru 63rd

Trending & Forecasting

ION™ technology

Cycle by Cycle RMS

Sequence of Event

4 Current Inputs

Connectivity

MODBUS, DNP3 and IEC61850

Dual port Ethernet

Gateway

Custom Web Interface

SNMP with Traps

E-mail historical data

Modbus mastering

E-mail notification

Advanced Utility Metering

Advanced Utility Metering

Segments

- Grid-Level Utilities (National/ISO)
- Transmission companies
- Distribution Utilities
- Power Generation
- Renewables (Wind/Solar)
- Municipal Utilities

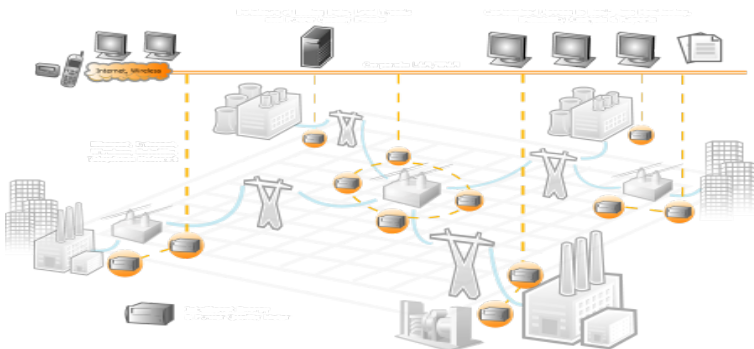

Applications

Revenue Metering

Co-generation / IPP Monitoring

Power Quality Compliance Monitoring

Demand & Power Factor Control

Substation Automation

Load Curtailment

**Instrument Transformer
Loss Compensation**



Communications and interoperability

The ION8650/ION8800 offers complete communications: Ethernet, serial, and modem

- ★ Gateway functionality simplifies communications architecture and reduces leased line or connection costs
- ★ Ports communicate with a variety of protocols (ION, DNP 3.0, Modbus™ RTU, Modbus TCP, IEC 61850, Modbus Master, MV-90, DLMS)
- ★ Meters have the capability to dial out when memory is near full and to push data through SMTP (email)



Growth Opportunities with PowerLogic

Entry Range



EM3500

Basic Range



6200



PM5100



PM5300



PM5500



Enercept

Intermediate Range



PM8000



ION7400

Advanced Range



ION7550/7650

Current Transformer



Current Transformers

Multi-Circuit Metering



EM4800



BCPM



BCPME



HDM

Utility Revenue



ION8650

Application Based Positioning

Energy Management Framework

Reduce energy cost

Energy Cost Management

- Energy Savings
- Energy Optimisation
- Carbon & Procurement optimization

Increase comfort or productivity

ED Network Management

- Protection
- Monitoring
- Control

Optimize equipment utilization

Asset Management

- Use Optimisation
- Condition Based Monitoring
- Predictive Maintenance

Simple cost management

Simple network management

- Market price
- Transactional sales

Expert network management

Expert asset management

- Performance & customization
- Premium price
- Consultative sales

Expert cost management

Expert network management

Simple asset management

- Premium price
- Consultative sales

Advanced Utility

Advanced

Basic

Entry Medium

Entry

Cost management

Network management

- Cost-effective
- Transactional sales
- Consultative sales

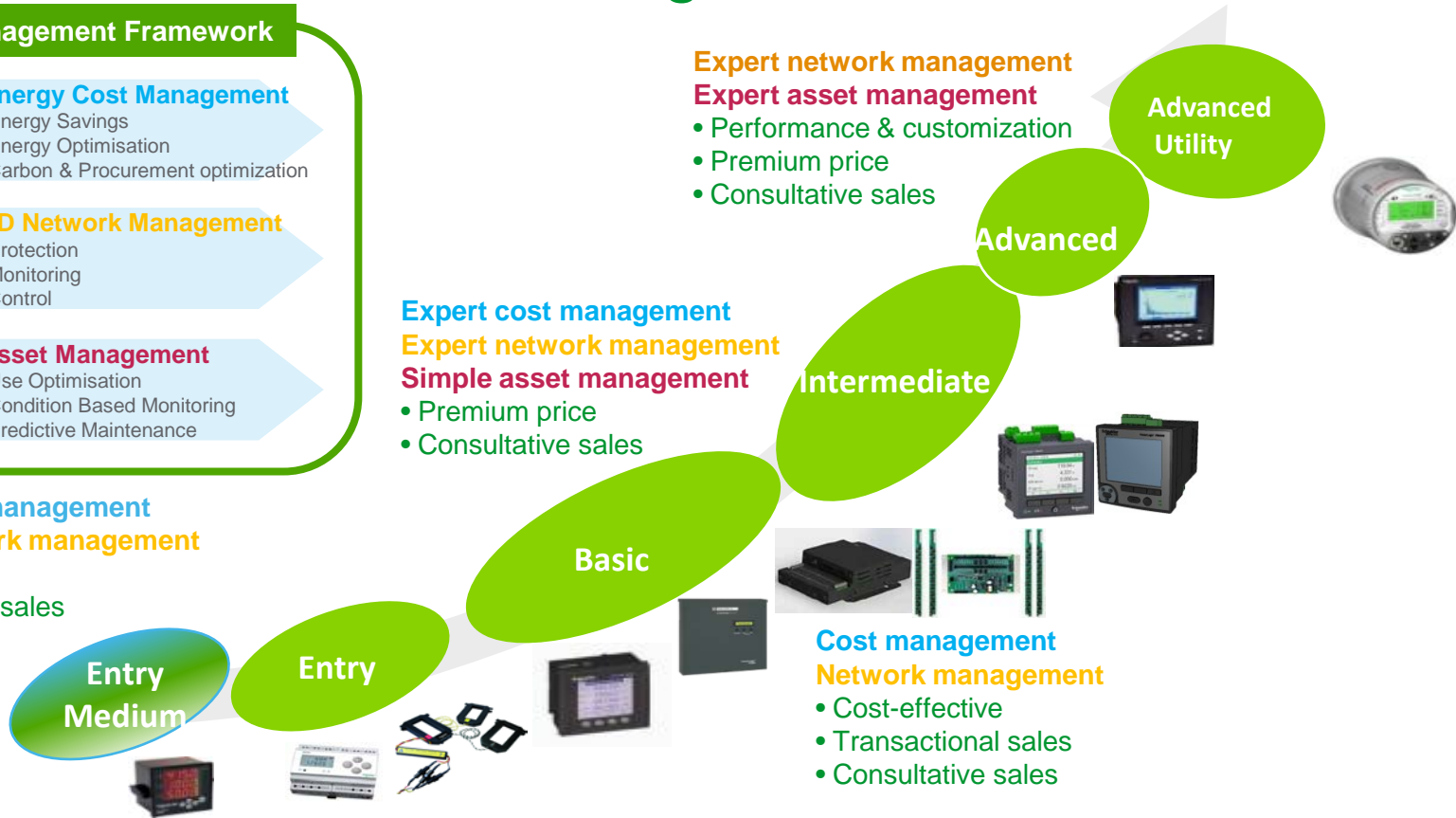

Make the most of your energy



Questions?

